



Welcome

**PCN Attachment
CBE250013
Additional marking
groove PT 2,5
COMBI**



CLIPLINE complete COMBI – Additional marking groove PT 2,5 COMBI

Agenda

- > Background
- > Old & New
- > Article list & Version code
- > Schedule

CLIPLINE complete COMBI – Additional marking groove PT 2,5 COMBI

Background

Additional marking groove

To standardize the CLIPLINE complete COMBI portfolio, the design of the PT 2,5 COMBI terminal blocks will be changed in one detail: The plug zone will be equipped with a marking groove. This feature is already available at several COMBI terminal blocks and beneficial to identify the COMBI connection point in the wiring process of control panels. As an example, the additional marking groove is implemented in the existing PT 4/1P.

PT 4/1P – additional marking groove existing

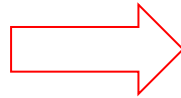
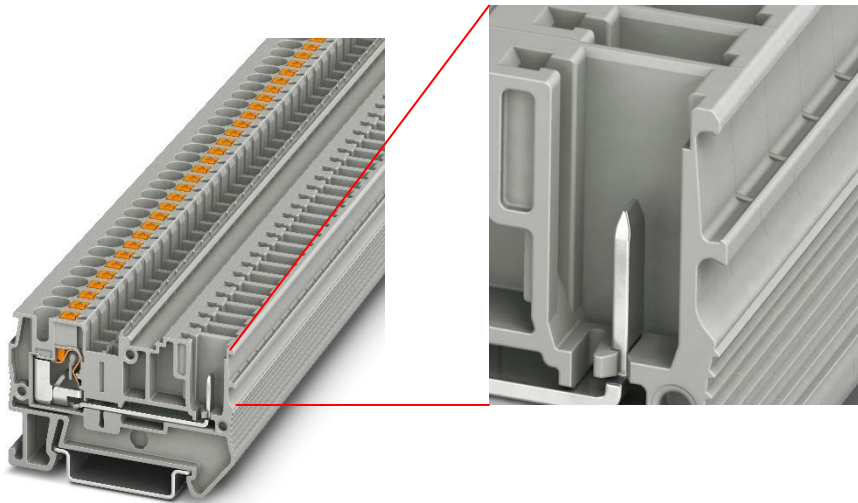

PT 2,5/1P – additional marking will be added

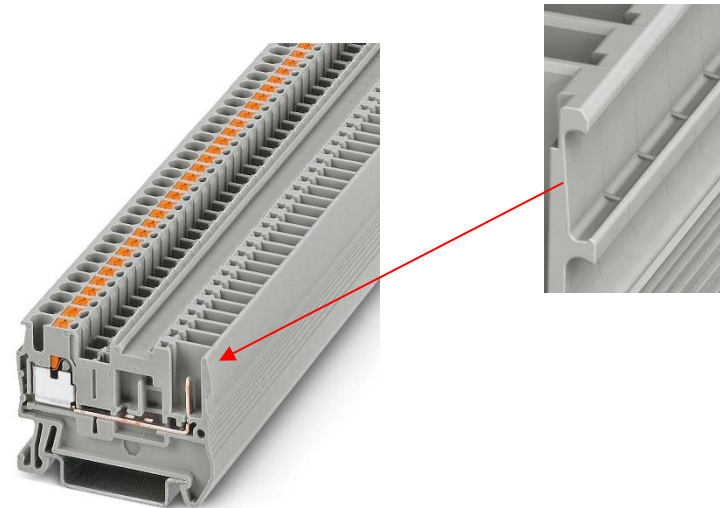

CLIPLINE complete COMBI – Additional marking groove PT 2,5 COMBI

Background

Additional marking groove

Other products of the COMBI product family will be changed as soon as replacements or other changes are due for the relevant tools. As this can have various backgrounds, the timing is not yet fixed for all products. We will inform via PCN for every single change.

CLIPLINE complete COMBI – Additional marking groove PT 2,5 COMBI

Old & New – Changes in detail(See next slide for complete article list)

PT 2,5/1P

Old

New

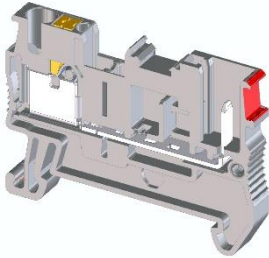
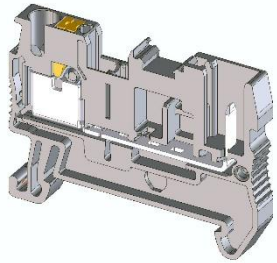

PT 2,5-TWIN/1P

Old

New

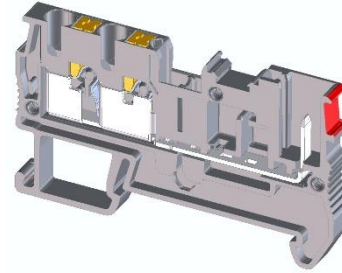
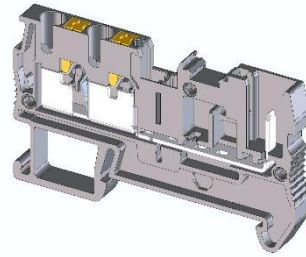

PT 2,5-QUATTRO/1P

Old

New

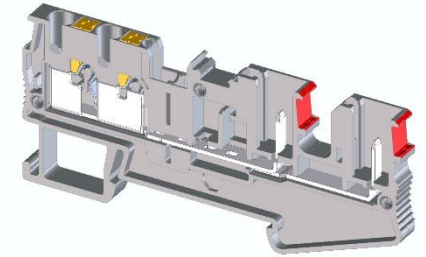
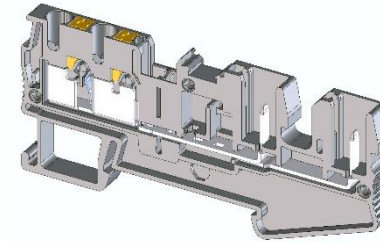

PT 2,5/1P-PE

Old

New

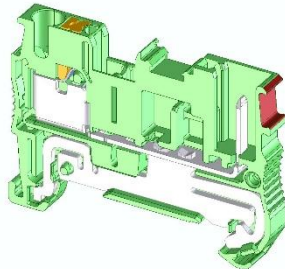
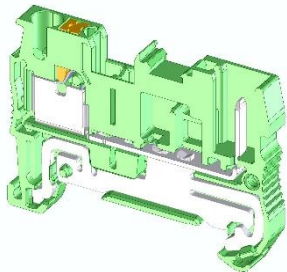

PT 2,5-TWIN/1P-PE

Old

New

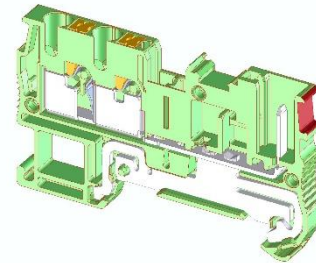
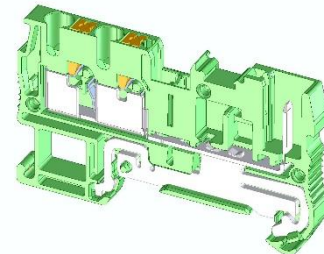

PT 2,5-TWIN/1P-PE

Old

New

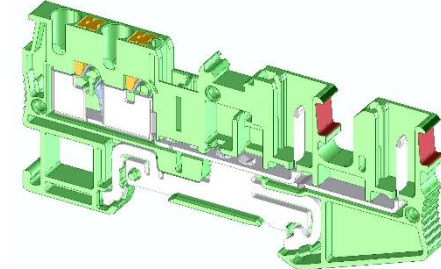
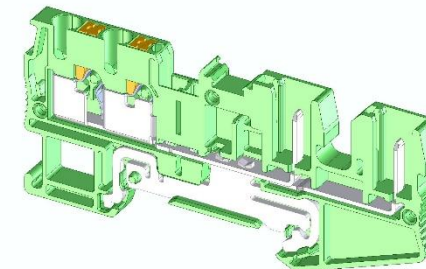

CLIPLINE complete COMBI – Additional marking groove PT 2,5 COMBI

Article list & Version code

Mat. No	Type	Version code old	Version code new
3210033	PT 2,5/1P	09	10
3210046	PT 2,5/1P BU	09	10
3210047	PT 2,5/1P OG	06	07
3210059	PT 2,5/1P-PE	10	11
3209633	PT 2,5-TWIN/1P	11	12
3209647	PT 2,5-TWIN/1P BK	07	08
3209646	PT 2,5-TWIN/1P BU	11	12
3209636	PT 2,5-TWIN/1P GN	08	09
3209634	PT 2,5-TWIN/1P RD	08	09
3209635	PT 2,5-TWIN/1P YE	08	09
3209659	PT 2,5-TWIN/1P-PE	11	12
3209662	PT 2,5-QUATTRO/2P	12	13
3209675	PT 2,5-QUATTRO/2P BU	12	13
1149032	PT 2,5-QUATTRO/2P RD	03	04
3209688	PT 2,5-QUATTRO/2P-PE	12	13

CLIPLINE complete COMBI – Additional marking groove PT 2,5 COMBI

Schedule

EOP:

The effective date for the changes will be the

19.12.2025

At this time, we will switch production to the new version code. A packing unit will only contain products from one version code, but deliveries containing several packing units **may contain** packing units with different version codes!

Project Complete data

The data base of the project complete software will be updated with the Spring 2026 release. The additional marking groove can be planned from than on

ClipX Engineer data

The data base for the ClipX Engineer will be update immediately with the EOP date(approx. 2 days later)

All contents in this presentation, in particular texts, photographs and graphics, are protected by copyright and all strategies, models, concepts and conclusions contained in this presentation are also the intellectual property of Phoenix Contact, unless otherwise indicated, for example by references. All information contained in this presentation is to be treated as confidential. It is prohibited to copy, modify, reproduce, publish, distribute or make this presentation available to third parties in any other way, either in whole or in part, without the prior written permission of Phoenix Contact.