

Gas Discharge Tube

Features

- Small Size Design EIA 1812 4.5×3.2×2.7mm
- Current Handling Capability 2,000A @ 8/20μ s
- Low Capacitance and Insertion Loss
- Fast Response and Long Service Life
- Reliable to Protect Electrostatic Surge
- Moisture sensitivity level: Level 1

Exterior

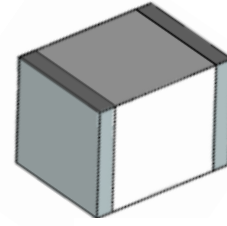

SMD

Application Information

- Coaxial

Package (Top View)

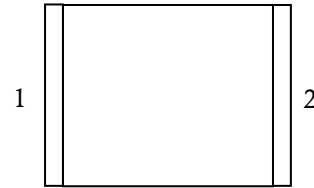

Agency Approvals

Icon	Description
<b>RoHS</b>	Compliance with 2011/65/EU
<b>HF</b>	Compliance with IEC61249-2-21:2003
	Mean lead free

Schematic Symbol

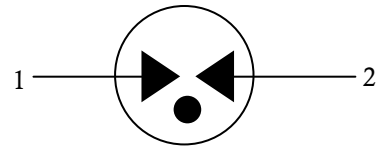

Electrical Parameter

DC Breakdown Voltage 1)2)	100V/s	63-117	V
Impulse Spark-over Voltage	At 1kV/μs	for 99 % of measured values ≤ 650	V
	At 1kV/μs	Typical values of distribution ≤ 550	V
Impulse Discharge Current 3)	8/20μs, ± 5times	2,000	A
	8/20us, ± 50times	100	
	10/1000us, ± 50times	10	
AC Discharge Current	50Hz, 1S, 10times	2	A
Arc Voltage	At 1A	~8	V
Insulation Resistance	DC=50V	≥1	GΩ
Capacitance at 1 MHz	VDC=0.5V	≤0.5	pF
Weight		~0.20	g
Operating And Storage Temperature		-40-90	°C
Marking		Without	

1) At delivery AQL 0.65 level II ISO 2859

2) In ionized mode

3) Terms and waveforms in accordance with ITU-T Rec. K. 12; IEC 61643-21

Gas Discharge Tube

Version: A2 2017-08-08

**Part Numbering System**

BC 091 N

(1) (2) (3)

(1) Bencent Gas Discharge Tube

(2) Series: DC Breakdown Voltage, e.g.: 091=9×101=90V

(3) Tolerance of DC Breakdown Voltage, M=+20%, N=+30%, the Specific tolerance is decided by the table of “Electrical Parameter”

**Product Characteristics**

Lead Material	Copper or iron nickel alloy
Body Material	Ceramics
Terminal Finish	100% Matte-Tin Plated

**Environmental Reliability Characteristics**

Testing items	Technical standards
High Temperature Storage Test	Temperature: 90°C Time: 2H
Low Temperature Storage Test	Temperature: -40°C Time: 2H
Vibration	Frequency: 10-500Hz Amplitude: 0.15mm Time: 45mins
Resistance of soldering heat	Temperature: 260±5°C Time of dip soldering: 10s, 1time

Note: Up-screen program can be specified by customer’s request via contacting Bencent service

**Solderability Test**

Solderability	Solder Pot Temperature:	245°C ± 5°C
	Solder Dwell Time:	4-6 seconds

**Product Dimensions**

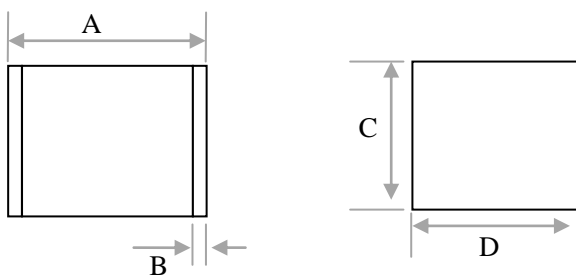

REF	mm	inch
A	4.5±0.3	0.177±0.012
B	0.5±0.2	0.020±0.008
C	2.7±0.2	0.106±0.008
D	3.2±0.2	0.126±0.008

**Recommended Soldering Pad**

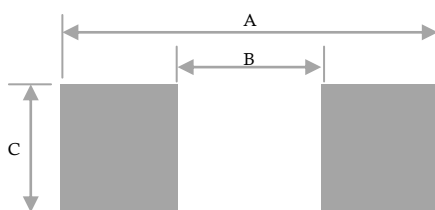

REF	mm	inch
A	5.5	0.217
B	3.5	0.138
C	3.5	0.138

Reflow Profile

Reflow Condition		Pb-Free assembly
Pre Heat	Temperature Min	150 °C
	Temperature Max	200 °C
	Time (min to max)	60 – 180 secs
Average ramp up rate (Liquids) T <sub>amp</sub> (T <sub>L</sub> ) to peak		3 °C/second max
T <sub>S</sub> (max) to T <sub>L</sub> - Ramp-up Rate		3 °C/second max
Reflow	- Temperature (T <sub>L</sub> ) (Liquids)	217 °C
	- Temperature (T <sub>L</sub> )	60 – 150 seconds
Peak Temperature (T <sub>P</sub> )		260+0/-5 °C
Time within 5 °C of actual peak Temperature (t <sub>p</sub> )		8 – 20 seconds
Ramp-down Rate		6 °C/second max
Time 25 °C to peak Temperature (T <sub>P</sub> )		8 minutes Max.
Do not exceed		260 °C

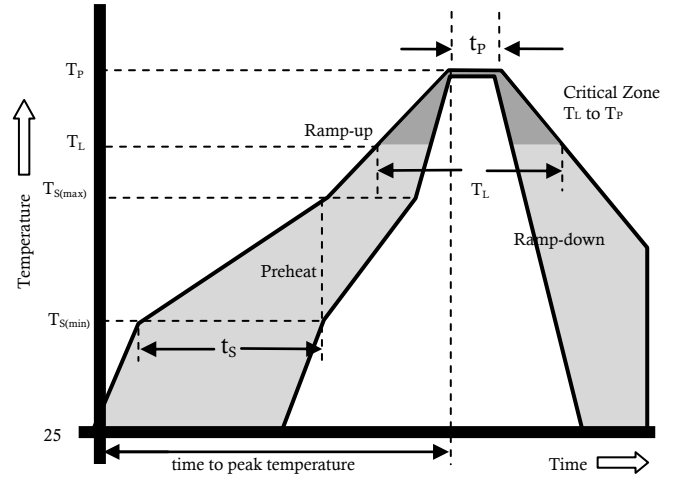

Package Reel Information

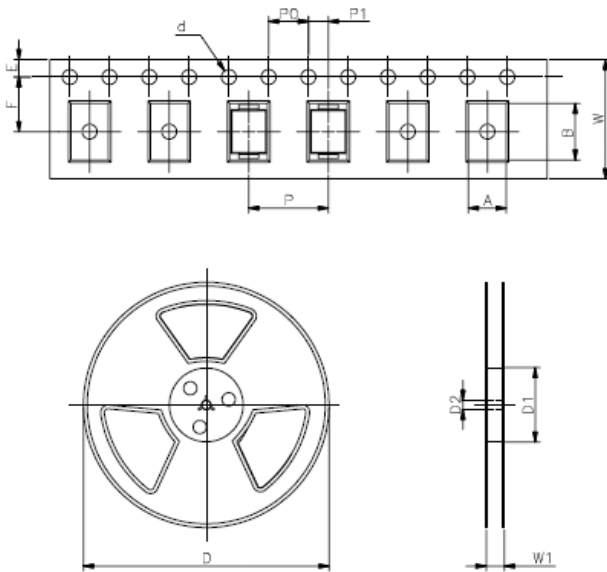

REF	mm	inch
A	3.7±0.2	0.146±0.008
B	5.0±0.1	0.197±0.004
d	Φ 1.5±0.1	Φ 0.059±0.004
E	1.75±0.1	0.069±0.004
F	5.5±0.1	0.217±0.002
P	8.0±0.1	0.315±0.004
P0	4.0±0.1	0.157±0.004
P1	2.0±0.1	0.079±0.004
W	12.0±0.2	0.472±0.008
D	Φ330.0	Φ13.0
D1	Φ50Min	Φ1.97Min
D2	Φ13±0.15	0.512±0.006
W1	16.8±2.0	0.661±0.079

OUTLINE	REEL (PCS)	PER CARTON (PCS)	REEL DIAMETERS (mm)	CARTON SIZE(mm)		
				L	W	H
TAPING	2,500	40,000	330	360	360	380